

Play value

Our Street Acrobats consist of several small space elements that offer various opportunities for hiding and going through openings. The cosiness of the little niches also provides the children with enough space for fantasy-full role-playing games. The equipment can be accessed via a connecting bridge element, and the bent firemen's pole allows a swift getaway to the ground.



Order No 4.16100 Street Acrobats Type 01



© Richter Spielgeräte GmbH 01/22

Design B. Poth-Lengefeld

Fundamental characteristics

- Child-oriented dimensions according to ergonomic knowledge
- The space-defining design appeals to the senses
- High-quality design
- Numerous play offers
- Incentive for playing: cosy rooms, firemen's pole, role-playing game
- Movement: climbing, sliding, balancing

Recommended for

- Kindergarten children
- Supervised play areas, such as kindergartens, schools after-school programmes or similar
- Public play areas without supervision, such as playgrounds, parks or similar

Planning information

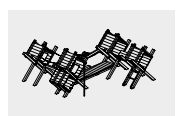

Our Street Acrobats can be put together individually. Other variants are possible on request.

**Street Acrobats
Type 04**



4.16104

Order No. 4.16104
Street Acrobats Type 04

Safety distance 
 Device dimensions 
 Functional distance 

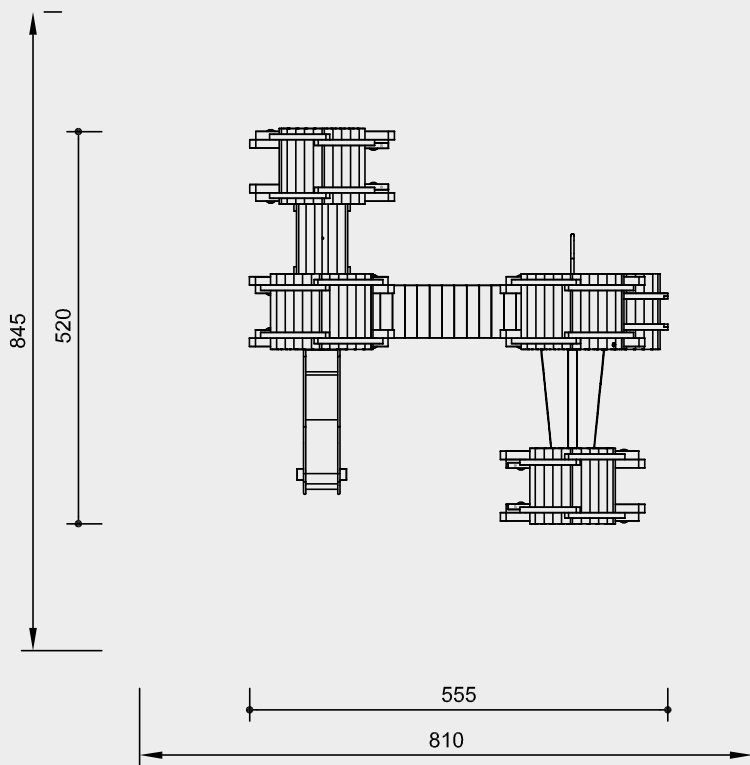
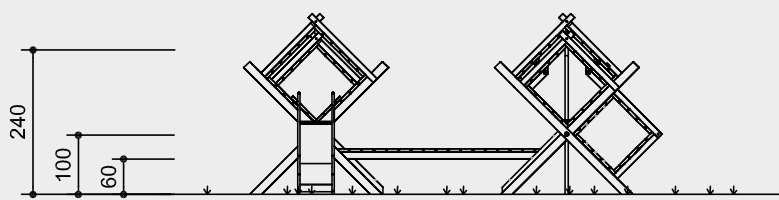

Scale 1:100

Safety check according to DIN EN 1176

Components

- 4 Cubes with frame with steel feet
- 1 Cube for attachment
- 1 Bent firemen's pole
- 1 Rope tree
- 1 Ravine bridge
- 1 Rigid bridge
- 2 Ladders
- 1 Balancing beam
- 1 Stainless steel slide with seat for Street Acrobats with ground anchor installation height 1.00 m width 0.45 m

Installation information

Surfacing requirements corresponding to a fall height of ≤ 1.00 m (please refer to price list for more detailed information)

- Foundations**
- 4 items 120 x 60 x 50 cm
 - Excavation depth 70 cm
 - 4 items 100 x 60 x 50 cm
 - Excavation depth 70 cm
 - 1 item 30 x 30 x 30 cm
 - Excavation depth 60 cm

Slide
 Excavation depth for ground anchor 55 cm

Attention:
Exact measurements may vary;
for all installation dimensions refer to current assembly instructions.
 Technical changes reserved.

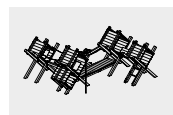

4.16104

Technical information

Equipment made of non-impregnated mountain larch

Core-free

Sawn-timbers core-free, thus decreasing occurrences of cracking and undesired changes in shape



Tongue and groove

Tongue and groove planks made of 4 cm solid wood, highly resilient, no trickling of dust / sand, protection against direct rain



Hardwood rungs

Climbing rungs made of hardwood (ash) \varnothing 4.2 cm, milled and mortised, secured against twisting, easy to grip and not cold for children to touch



Profiled washer

Profiled washer for covering protruding screw heads according to standard, improved pressure distribution and protection against water. Impedes loosening the bolt



Adjustable

Adjustable two-piece bolt connection, easy to maintain, no projecting threads



Ground anchor

All parts used for anchoring to the ground are made of hot-dip galvanized steel or stainless steel



Chains

Chains made of hot-dip galvanized steel (1.4301 / 1.4571 at extra charge) welded before galvanising, short-linked, without eyelets on the connecting parts, easy to exchange and shorten



For more detailed explanation of the quality characteristics see price list.

Firemen's pole, stainless steel, glass-bead blasted

Dimensions

(small deviations possible)

Height	2.40 m
Floor height	1.00 m
Height of bridge	0.60 m
Length	5.55 m
Width	5.25 m