

Play value

Water can be found in the space within a transparent board where small particles create clear patterns. The board can be very easily set into a gentle pendulum motion due to the large, heavy counterweights. This rhythm effect causes designs to form. Water currents which collide into a wall create waves whose structure resembles sand on the bottom of the ocean. It can be clearly seen how the water flows around the obstacles and flows more quickly through the narrow canals. Typical flowing patterns build up in front of obstacles and in the water eddy behind them.

The slow progress of this activity requires patience and encourages the observer to watch attentively. We experience time through daily rhythm, e.g. the rhythm of day and night. The rhythm of the currents is an expression of time which can be directly experienced. And it is in this way that the game taps into people's natural rhythm and moods.

Recommended for

- School children
- Young people
- Adults
- Older people
- Public play areas without supervision, such as playgrounds, parks or similar

Barrier-free

- Independent play

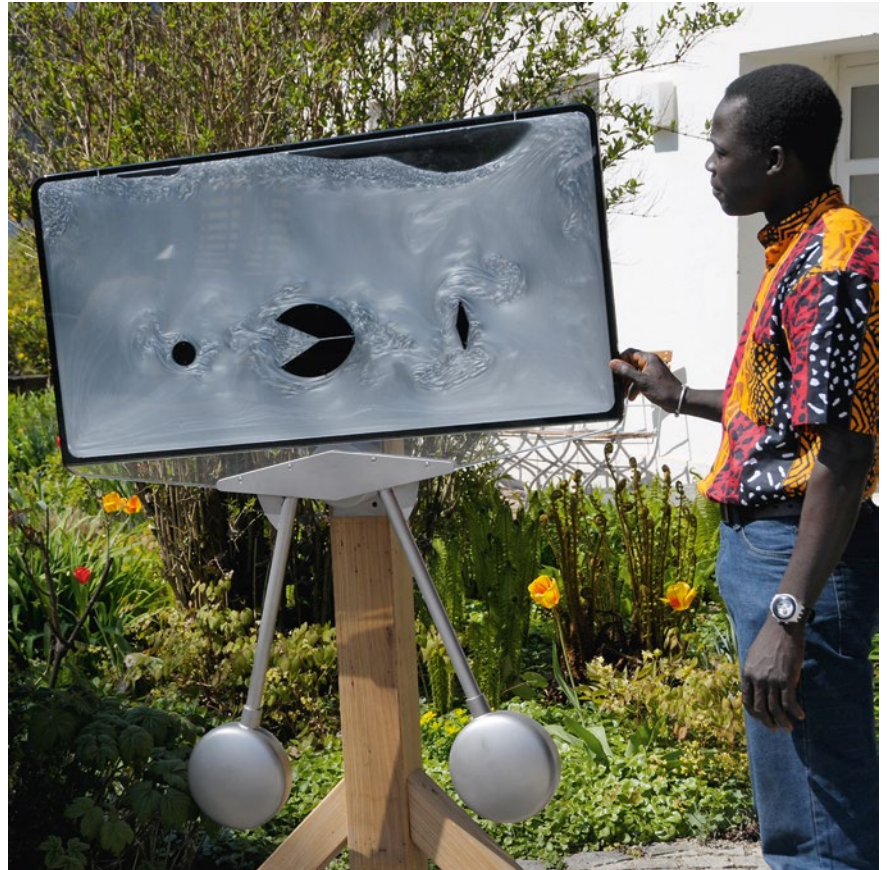

Order No. 10.15005 with support post made of stainless steel

Vandalism	vulnerable in non-supervised areas
Supervision	not necessary
Explanation Board	recommended
Installation	indoors and outdoors
Safety check (DIN EN 1176)	has been completed
Installation in concrete	possible

Pattern Board

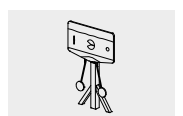

10.15000

Order No. 10.15000
Pattern Board

Safety distance 
 Device dimensions 
 Functional distance 

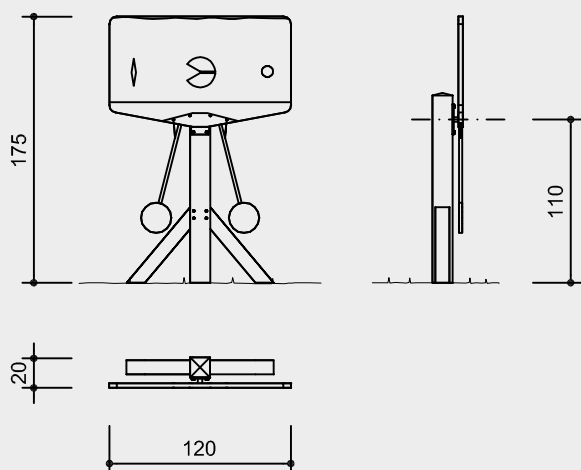

Scale 1:50

Safety check according to DIN EN 1176

Components

- 1 Pattern board
- 1 Rack

Trademark

30 2005 500 000 Germany
 40-0682207 South Korea

Explanation board on request

Installation information

Recommended space
 3.00 x 3.00 m

Foundations
 2 items 50 x 30 x 30 cm
 Excavation depth 50 cm
 1 item 40 x 40 x 40 cm
 Excavation depth 60 cm

Attention:
Exact measurements may vary;
for all installation dimensions refer
to current assembly instructions.
 Technical changes reserved.
Equipment also available with stand
posts made of stainless steel
(Order No. 10.15005) or for wall
attachment (Order No. 10.15500).

Technical information

Equipment made of oak

Core-free

Sawn-timbers core-free, thus decreasing occurrences of cracking and undesired changes in shape



Roller bearings

High-quality roller bearings made of chrome steel or stainless steel for rotating elements, easy to maintain and exchange, sealed



For more detailed explanation of the quality characteristics see price list.

Extremely impact-resistant acrylic double screen

Special algae-free glycol mixture as high-contrast flow liquid, frostproof to approx. -25° C

Dimensions

(small deviations possible)

Height	1.75 m
Width	1.20 m
Depth	0.20 m
Weight	60 kg
with packing material	100 kg

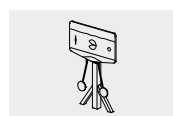

10.15000